

Specifications:

Sound level Category	Loud Sound Level
Mode of Operation	Fast Pulse
Mounting	Panel (see note B)
Voltage Rating	10 to 48 Vac/dc
Frequency	2900 Hz ±500 Hz
Loudness (Min. Voltage)	80 dB(A) min. @ 2 FT and 10 Vac/dc
Loudness (Max Voltage)	95 dB(A) min. @ 2FT and 48 Vac/dc
Current Draw	4 mA Max @ 10 Vac/dc
Current Draw	26 mA Max @ 48 Vac/dc
Min Pulse Rate (PPS)	2 @ 10 Vac/dc
Max Pulse Rate (PPS)	10 @ 48 Vac/dc
Duty Cycle (%)	50 (Approx)
Storage Temperature	-40°C to +85°C
Operating temperature	-30°C to +65°C
Weight (Typical)	2.1 oz (59 g)
Housing	6/6 Nylon, Color Black
Options	For other options contact factory

Dimensions: Inches (mm)



PART DIMENSIONS BEFORE CODE DATE 0809 5

PART DIMENSIONS AFTER CODE DATE 0810 1

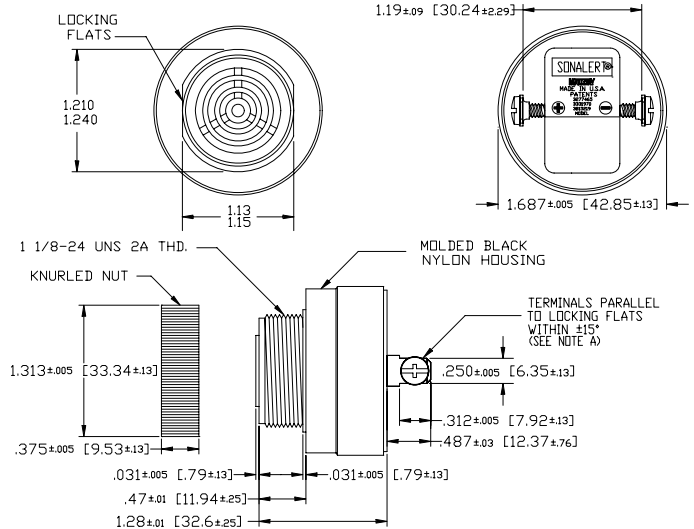
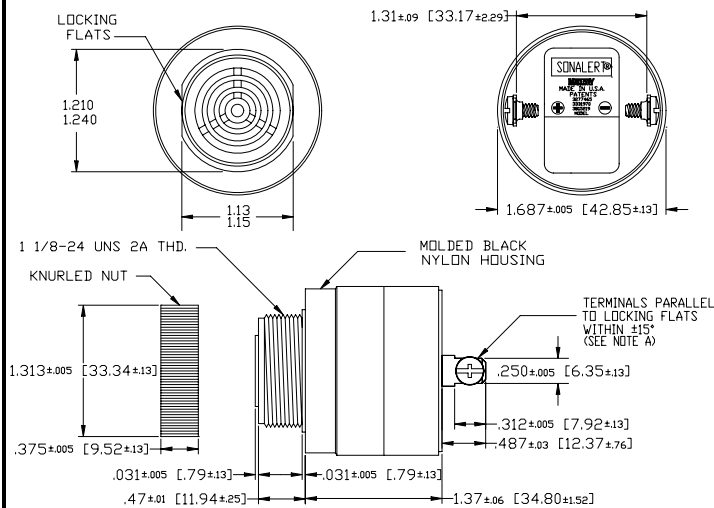

NOTE A: TERMINALS-.032 BRASS TIN PLATED, TAPPED FOR #6-32 SCREW. TWO #6-32 NICKEL PLATED BRASS SCREWS INCLUDED. WILL ACCEPT 1/4" QUICK CONNECT.

NOTE B: MOUNTING- REMOVE BLACK PLASTIC NUT AND INSERT THREADED FRONT THROUGH 125° HOLE PUNCHED IN PANEL. IF ORIENTATION IS NEEDED, NOTE LOCKING FLATS ON DRAWING. SCREW NUT BACK ON. DO NOT OVERTIGHTEN.

NOTE A: TERMINALS-.032 BRASS TIN PLATED, TAPPED FOR #6-32 SCREW. TWO #6-32 NICKEL PLATED BRASS SCREWS INCLUDED. WILL ACCEPT 1/4" QUICK CONNECT.

NOTE B: MOUNTING- REMOVE BLACK PLASTIC NUT AND INSERT THREADED FRONT THROUGH 125° HOLE PUNCHED IN PANEL. IF ORIENTATION IS NEEDED, NOTE LOCKING FLATS ON DRAWING. SCREW NUT BACK ON. DO NOT OVERTIGHTEN.